

**IEK**



**TO  
THE  
E**

**Wiring  
Accessories**

**TURN  
ON**

<b>About IEK GROUP</b>	<b>1</b>
<b>Advantages</b>	<b>3</b>
<b>Installation</b>	<b>5</b>
<b>Colors</b>	<b>6</b>
<b>Range</b>	
Switches	<b>8</b>
Sockets	<b>16</b>
Telecommunication sockets	<b>22</b>
USB sockets and lighting	<b>26</b>
Frames	<b>30</b>

**TURN ON LETO**



## ABOUT IEK GROUP

IEK GROUP is a Russian electrical engineering company, manufacturer and supplier of electrical equipment IEK, tekfor, lighting equipment IEK, LEDEL and FERREKS, products for IT technologies ITK, industrial automation equipment ONI, solar energy systems NEOSUN. IEK GROUP also includes the MPS Soft company, the developer of the MasterSCADA software.

IEK GROUP pays special attention to quality control. All products are tested in our own laboratory, as well as in leading testing and certification centers in Russia.

Thanks to their reliability, quality and ease of use, IEK products have won great consumer trust. The IEK brand has repeatedly become a laureate of the "Brand No. 1 in Russia" rating in the "Electrical equipment" category.





The founders of IEK GROUP started their business in the electrical market in 1999. The company has accumulated vast experience, created a strong R&D, developed production and logistics facilities and today is a serious competitor to the world's leading manufacturers. The company offers a wide range of equipment for integrated solutions in construction, housing and communal services, transport, infrastructure, industry, energy, telecommunications and other industries.

**IEK GROUP in numbers:**

- 25 years of successful work;
- nearly 3,500 employees;
- more than 100,000 square metres of production facilities;
- more than 30 thousand items in product range.

[iekglobal.vn](http://iekglobal.vn)

Where to buy IEK



Wide distribution network allow IEK GROUP to be represented in all regions of the Russian Federation, CIS and Southeast Asia.

## ADVANTAGES



A durable universal support allows you to assemble various mechanisms of sockets and switches. Strength is determined by the thickness of the metal and is 1.2 mm. Also, for additional rigidity, stiffening ribs are made in the places where the support is attached to the wall and the mounting box. To protect against corrosion, the metal caliper is painted black.



There are four standard sizes of frames (1/3, 1/2, 2/3, 3/3), for mechanisms 1/3, 1/2, 3/3 or for their different combinations. The frames are made of high-quality plastic (polycarbonate), do not support combustion and do not emit harmful substances at high temperatures (tested according to the RoHS standard). The design of the frames has centering lugs on the rear, allowing you to quickly install the frame on a metal support without using of any tools.



The universal and thoughtful design of the product allows you to equip the metal support with any mechanisms at any time. There are mechanisms of standard sizes 1/3, 1/2, 2/3 3/3. You can use a 3/3 size mechanism, it will take up all the space, you can also use two 1/2 mechanisms or, for example, three pieces 1/3 mechanisms and they will also take up all the usable space in a metal support. It is possible to install two pieces 1/3 mechanisms in a metal support on the sides, in this case you need to use a corresponding frame.

TURN ON LETO – choose your color and functionality!

- **Modern design**
- **Ergonomics**
- **Wide product range**
- **Premium materials**
- **The optimum ratio of price and quality**
- **Versatile and compact solution**

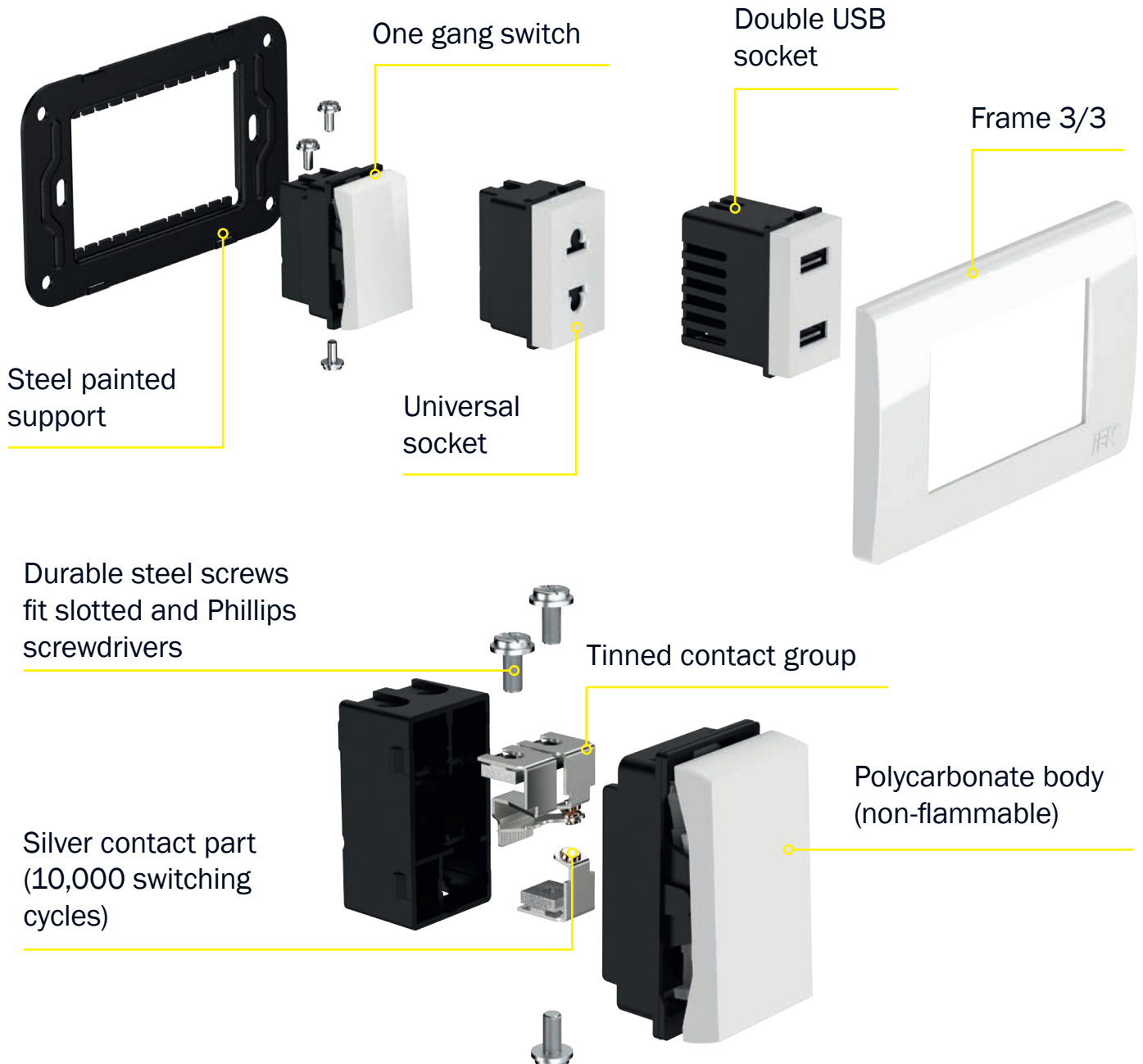

# INSTALLATION

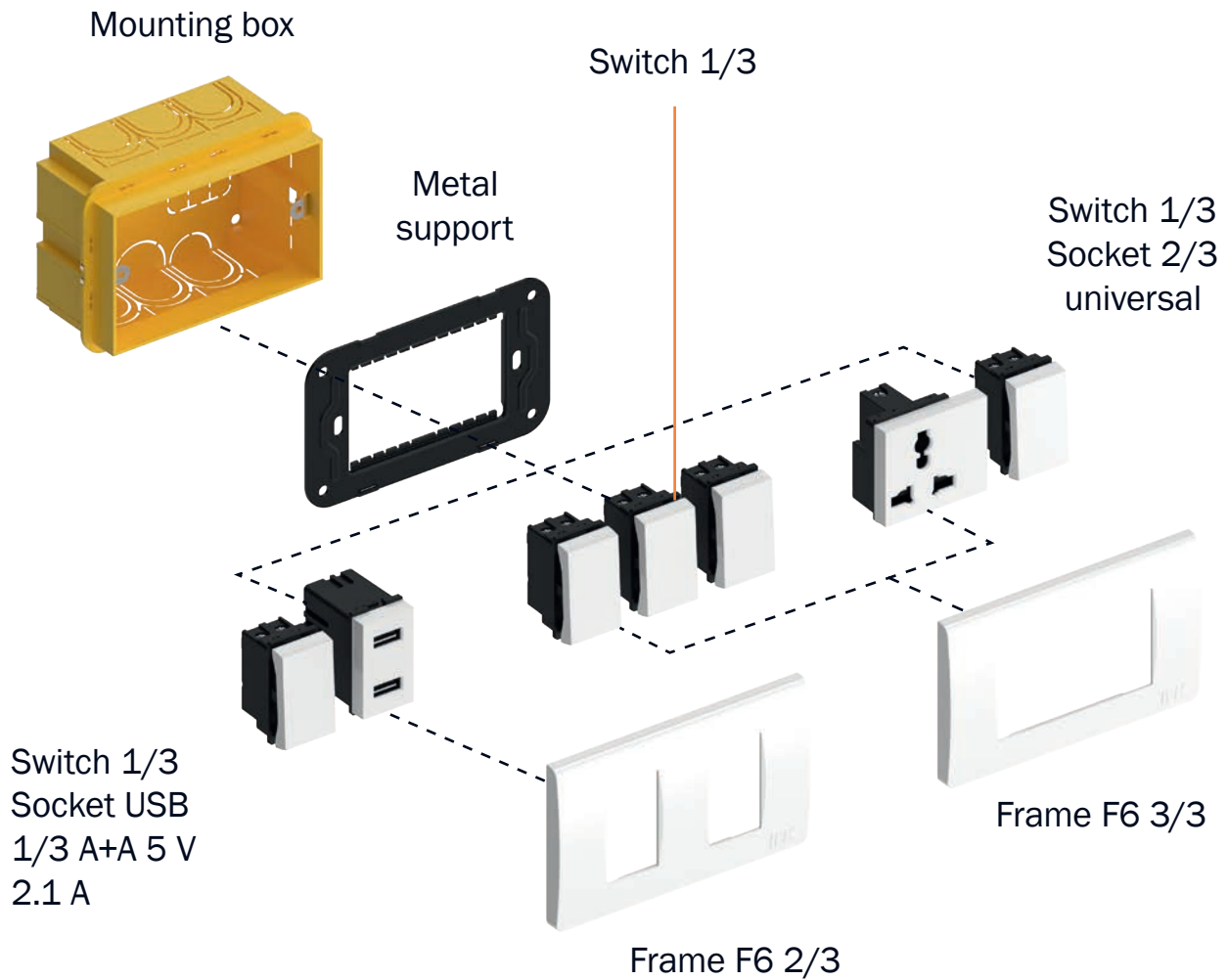

TURN ON **LETO**



Steel



Black



## COLORS

Colors such as white and beige, along with the soothing color of the wall surfaces, are always a good basis for any interior, traditional or modern. They bring lightness and balance to the environment, do not overload the interior, and go well with natural materials and decorative elements. Colors such as steel, bronze and rich black combine favorably with modern furniture and rich finishes. In such interiors, materials like velvet, marble, copper, and wood are often used. Using these textures you can create visual accents in interior elements and decor.

- **White gloss**
- **White matte**
- **Beige**
- **Champagne**
- **Bronze**
- **Steel**
- **Black**



White gloss



White matte



Champagne



Bronze



Beige

LETO



TURN ON



# SWITCHES

The LETO series switches have a compact mechanism and can take up only 1/3 of the space in the metal support, even if we are talking about a two-key switch. The switch consists of a high-quality processed brass contact group, durable stainless steel screws and the housing itself is made of high-quality plastic that does not support combustion, with markings on the rear.

- **Reliable contact group**
- **Modern SMD module of indication**
- **Simple and quick installation**



## Specifications

**Flush mounted**  
Installation type

**230 V/50 Hz**  
Rated voltage

**16 and 20 A**  
Rated current

**IP20**  
Protection degree

**Screws**  
Mounting method

**Screw terminals**  
Conductor connection

**From 1.5 to 4 mm<sup>2</sup>**  
Cross-section of connected conductors



### Switch 1/3 1 gang 1 way

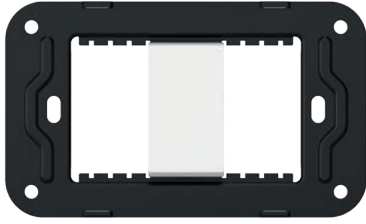

LE-V17-0-10-20-K01-F4-13	White glossy
LE-V17-0-10-20-K01-F3-13	White matte
LE-V17-0-10-20-K10-F3-13	Beige matte
LE-V17-0-10-20-K37-F3-13	Champagne matte
LE-V17-0-10-20-K45-F3-13	Bronze matte
LE-V17-0-10-20-K46-F3-13	Steel matte
LE-V17-0-10-20-K02-F3-13	Black matte

### Switch 1/3 2 gang 1 way

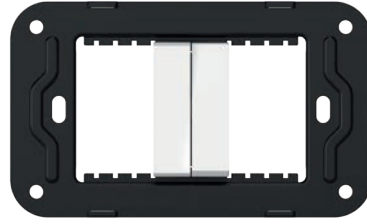

LE-V20-0-10-20-K01-F4-13	White glossy
LE-V20-0-10-20-K01-F3-13	White matte
LE-V20-0-10-20-K10-F3-13	Beige matte
LE-V20-0-10-20-K37-F3-13	Champagne matte
LE-V20-0-10-20-K45-F3-13	Bronze matte
LE-V20-0-10-20-K46-F3-13	Steel matte
LE-V20-0-10-20-K02-F3-13	Black matte

### Switch 1/3 1 gang 2 way

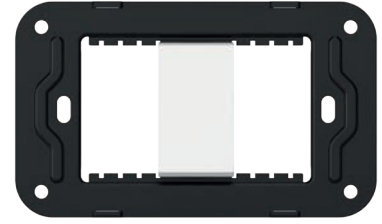

LE-V27-0-10-20-K01-F4-13	White glossy
LE-V27-0-10-20-K01-F3-13	White matte
LE-V27-0-10-20-K10-F3-13	Beige matte
LE-V27-0-10-20-K37-F3-13	Champagne matte
LE-V27-0-10-20-K45-F3-13	Bronze matte
LE-V27-0-10-20-K46-F3-13	Steel matte
LE-V27-0-10-20-K02-F3-13	Black matte

### Switch 1/3 1 gang doorbell



LE-ZD10D-KZ-13-K01-F4	White glossy
LE-ZD10D-KZ-13-K01-F3	White matte
LE-ZD10D-KZ-13-K10-F3	Beige matte
LE-ZD10D-KZ-13-K37-F3	Champagne matte
LE-ZD10D-KZ-13-K45-F3	Bronze matte
LE-ZD10D-KZ-13-K46-F3	Steel matte
LE-ZD10D-KZ-13-K02-F3	Black matte

### Switch 1/3 1 gang 1 way LED

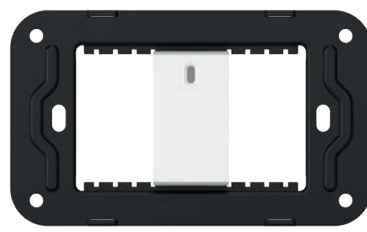

LE-V17-1-10-20-K01-F4-13	White glossy
LE-V17-1-10-20-K01-F3-13	White matte
LE-V17-1-10-20-K10-F3-13	Beige matte
LE-V17-1-10-20-K37-F3-13	Champagne matte
LE-V17-1-10-20-K45-F3-13	Bronze matte
LE-V17-1-10-20-K46-F3-13	Steel matte
LE-V17-1-10-20-K02-F3-13	Black matte

### Switch 1/3 1 gang 2 way LED



LE-V27-1-10-20-K01-F4-13	White glossy
LE-V27-1-10-20-K01-F3-13	White matte
LE-V27-1-10-20-K10-F3-13	Beige matte
LE-V27-1-10-20-K37-F3-13	Champagne matte
LE-V27-1-10-20-K45-F3-13	Bronze matte
LE-V27-1-10-20-K46-F3-13	Steel matte
LE-V27-1-10-20-K02-F3-13	Black matte

### Switch 1/3 1 gang doorbell LED



LE-ZD10D-KZ-11-K01-F4	White glossy
LE-ZD10D-KZ-11-K01-F3	White matte
LE-ZD10D-KZ-11-K10-F3	Beige matte
LE-ZD10D-KZ-11-K37-F3	Champagne matte
LE-ZD10D-KZ-11-K45-F3	Bronze matte
LE-ZD10D-KZ-11-K46-F3	Steel matte
LE-ZD10D-KZ-11-K02-F3	Black matte

### Switch 1/2 1 gang 1 way



LE-V17-0-10-20-K01-F4-12	White glossy
LE-V17-0-10-20-K01-F3-12	White matte
LE-V17-0-10-20-K10-F3-12	Beige matte
LE-V17-0-10-20-K37-F3-12	Champagne matte
LE-V17-0-10-20-K45-F3-12	Bronze matte
LE-V17-0-10-20-K46-F3-12	Steel matte
LE-V17-0-10-20-K02-F3-12	Black matte

### Switch 1/2 2 gang 1 way



LE-V20-0-10-20-K01-F4-12	White glossy
LE-V20-0-10-20-K01-F3-12	White matte
LE-V20-0-10-20-K10-F3-12	Beige matte
LE-V20-0-10-20-K37-F3-12	Champagne matte
LE-V20-0-10-20-K45-F3-12	Bronze matte
LE-V20-0-10-20-K46-F3-12	Steel matte
LE-V20-0-10-20-K02-F3-12	Black matte

**Switch 1/2 1 gang 2 way**



LE-V27-0-10-20-K01-F4-12	White glossy
LE-V27-0-10-20-K01-F3-12	White matte
LE-V27-0-10-20-K10-F3-12	Beige matte
LE-V27-0-10-20-K37-F3-12	Champagne matte
LE-V27-0-10-20-K45-F3-12	Bronze matte
LE-V27-0-10-20-K46-F3-12	Steel matte
LE-V27-0-10-20-K02-F3-12	Black matte

**Switch 1/2 1 gang doorbell**

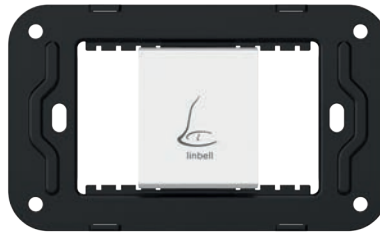

LE-ZD10D-KZ-12-K01-F4	White glossy
LE-ZD10D-KZ-12-K04-F3	White matte
LE-ZD10D-KZ-12-K10-F3	Beige matte
LE-ZD10D-KZ-12-K34-F3	Champagne matte
LE-ZD10D-KZ-12-K45-F3	Bronze matte
LE-ZD10D-KZ-12-K46-F3	Steel matte
LE-ZD10D-KZ-12-K02-F3	Black matte

**Switch 1/2 1 gang 1 way LED**



LE-V17-1-10-20-K01-F4-12	White glossy
LE-V17-1-10-20-K01-F3-12	White matte
LE-V17-1-10-20-K10-F3-12	Beige matte
LE-V17-1-10-20-K37-F3-12	Champagne matte
LE-V17-1-10-20-K45-F3-12	Bronze matte
LE-V17-1-10-20-K46-F3-12	Steel matte
LE-V17-1-10-20-K02-F3-12	Black matte

**Switch 1/2 1 gang 2 way LED**

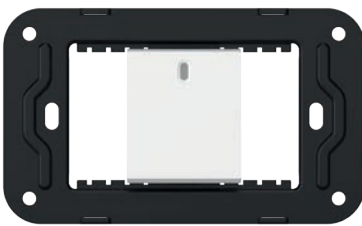

LE-V27-1-10-20-K01-F4-12	White glossy
LE-V27-1-10-20-K01-F3-12	White matte
LE-V27-1-10-20-K10-F3-12	Beige matte
LE-V27-1-10-20-K37-F3-12	Champagne matte
LE-V27-1-10-20-K45-F3-12	Bronze matte
LE-V27-1-10-20-K46-F3-12	Steel matte
LE-V27-1-10-20-K02-F3-12	Black matte

**Switch 1/2 1 gang doorbell LED**



LE-ZD10D-KZ-10-K01-F4	White glossy
LE-ZD10D-KZ-10-K01-F3	White matte
LE-ZD10D-KZ-10-K10-F3	Beige matte
LE-ZD10D-KZ-10-K37-F3	Champagne matte
LE-ZD10D-KZ-10-K45-F3	Bronze matte
LE-ZD10D-KZ-10-K46-F3	Steel matte
LE-ZD10D-KZ-10-K02-F3	Black matte

**Switch 1/2 20A 1 gang**



LE-V17-0-20-20-K01-F4-12	White glossy
LE-V17-0-20-20-K01-F3-12	White matte
LE-V17-0-20-20-K10-F3-12	Beige matte
LE-V17-0-20-20-K37-F3-12	Champagne matte
LE-V17-0-20-20-K45-F3-12	Bronze matte
LE-V17-0-20-20-K46-F3-12	Steel matte
LE-V17-0-20-20-K02-F3-12	Black matte

**Switch 3/3 1 gang 1 way**



LE-V17-0-10-20-K01-F4-33	White glossy
LE-V17-0-10-20-K01-F3-33	White matte
LE-V17-0-10-20-K10-F3-33	Beige matte
LE-V17-0-10-20-K37-F3-33	Champagne matte
LE-V17-0-10-20-K45-F3-33	Bronze matte
LE-V17-0-10-20-K46-F3-33	Steel matte
LE-V17-0-10-20-K02-F3-33	Black matte

**Switch 3/3 1 gang 2 way**



LE-V27-0-10-20-K01-F4-33	White glossy
LE-V27-0-10-20-K01-F3-33	White matte
LE-V27-0-10-20-K10-F3-33	Beige matte
LE-V27-0-10-20-K37-F3-33	Champagne matte
LE-V27-0-10-20-K45-F3-33	Bronze matte
LE-V27-0-10-20-K46-F3-33	Steel matte
LE-V27-0-10-20-K02-F3-33	Black matte

**Switch 3/3 1 gang doorbell**



LE-ZD10D-KZ-33-K01-F4	White glossy
LE-ZD10D-KZ-33-K01-F3	White matte
LE-ZD10D-KZ-33-K10-F3	Beige matte
LE-ZD10D-KZ-33-K37-F3	Champagne matte
LE-ZD10D-KZ-33-K45-F3	Bronze matte
LE-ZD10D-KZ-33-K46-F3	Steel matte
LE-ZD10D-KZ-33-K02-F3	Black matte

### Switch 3/3 1 gang 1 way LED



LE-V17-1-10-20-K01-F4-33	White glossy
LE-V17-1-10-20-K01-F3-33	White matte
LE-V17-1-10-20-K10-F3-33	Beige matte
LE-V17-1-10-20-K37-F3-33	Champagne matte
LE-V17-1-10-20-K45-F3-33	Bronze matte
LE-V17-1-10-20-K46-F3-33	Steel matte
LE-V17-1-10-20-K02-F3-33	Black matte

### Switch 3/3 1 gang 2 way LED



LE-V27-1-10-20-K01-F4-33	White glossy
LE-V27-1-10-20-K01-F3-33	White matte
LE-V27-1-10-20-K10-F3-33	Beige matte
LE-V27-1-10-20-K37-F3-33	Champagne matte
LE-V27-1-10-20-K45-F3-33	Bronze matte
LE-V27-1-10-20-K46-F3-33	Steel matte
LE-V27-1-10-20-K02-F3-33	Black matte

### Switch 3/3 1 gang doorbell LED



LE-ZD10D-KZ-09-K01-F4	White glossy
LE-ZD10D-KZ-09-K01-F3	White matte
LE-ZD10D-KZ-09-K10-F3	Beige matte
LE-ZD10D-KZ-09-K37-F3	Champagne matte
LE-ZD10D-KZ-09-K45-F3	Bronze matte
LE-ZD10D-KZ-09-K46-F3	Steel matte
LE-ZD10D-KZ-09-K02-F3	Black matte

## Specifications

**Flush mounted**  
Installation type

**500 W**  
Maximum power

**230 V/50 Hz**  
Rated voltage

**IP20**  
Protection degree

**Screws**  
Mounting method

**Screw terminals**  
Conductor connection

**From 0.75 to 2.5 mm<sup>2</sup>**  
Cross-section of connected conductors

## Dimmer 1/2 500 W



LE-D10-0500-K01-F4-12	White glossy
LE-D10-0500-K01-F3-12	White matte
LE-D10-0500-K10-F3-12	Beige matte
LE-D10-0500-K37-F3-12	Champagne matte
LE-D10-0500-K45-F3-12	Bronze matte
LE-D10-0500-K46-F3-12	Steel matte
LE-D10-0500-K02-F3-12	Black matte

# SIZES

## Switches

**3/3**

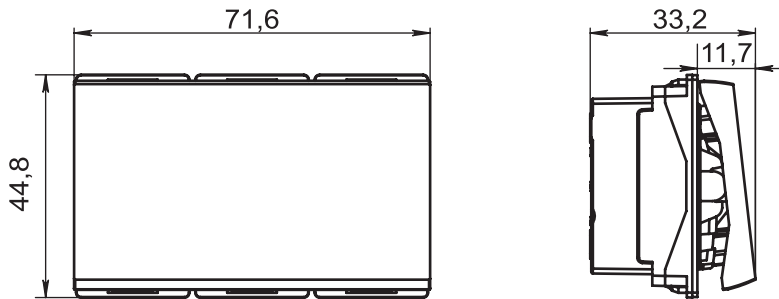

**1/2**

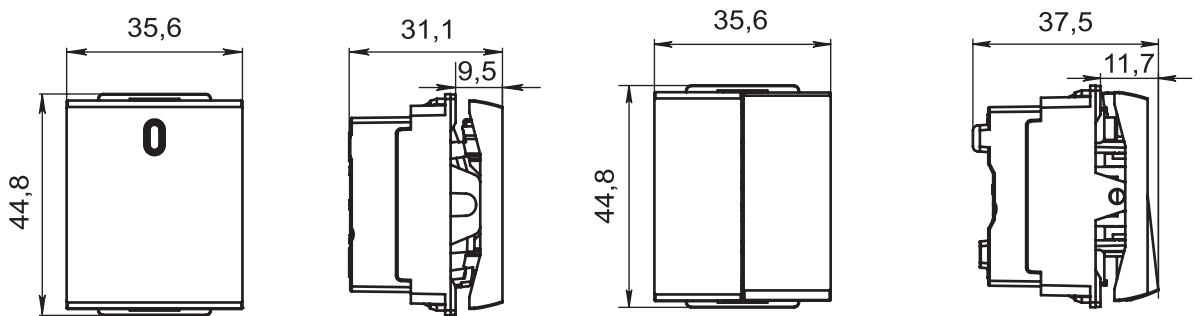

**1/3**

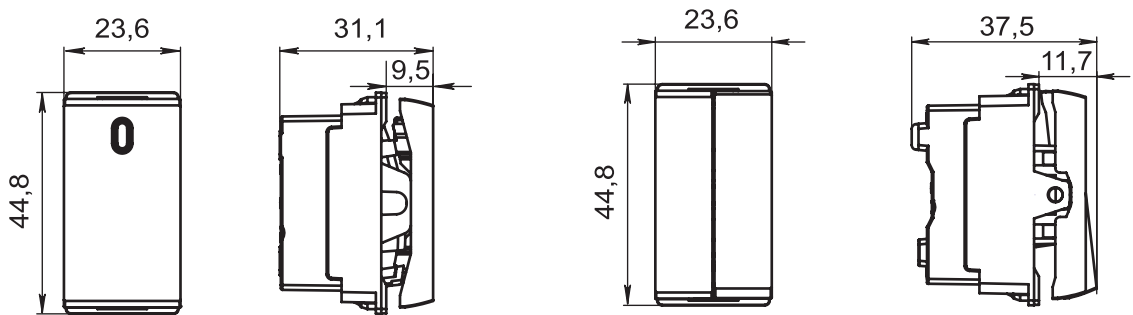

## Dimmer

**1/2**

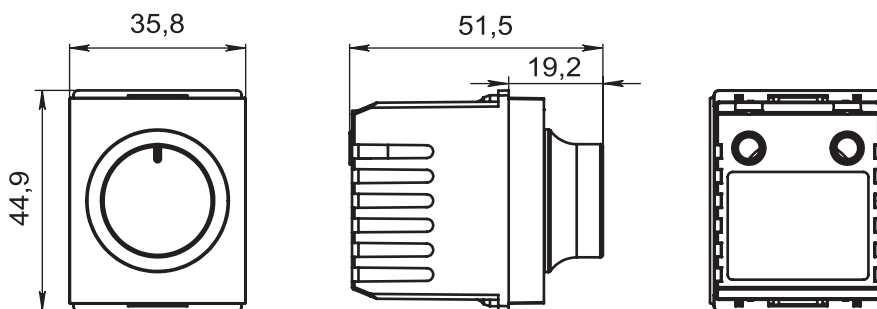

# ELECTRICAL SCHEME

Switch 1 gang 1 way

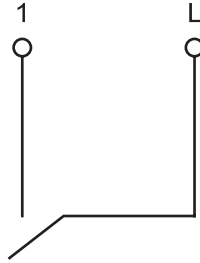

Switch 1 gang 2 way

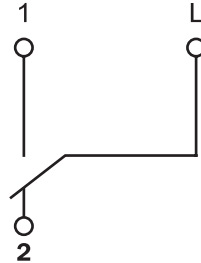

Switch 1 gang 1 way LED

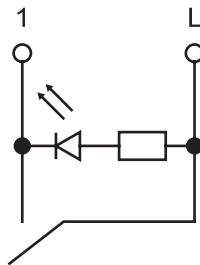

Switch 1 gang 2 way LED

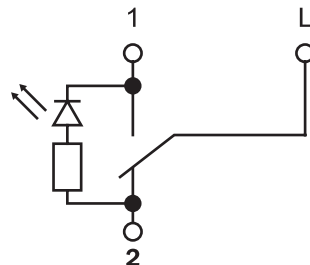

Switch 1 gang doorbell

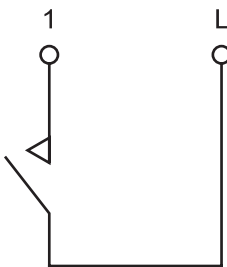

Switch 1 gang doorbell LED

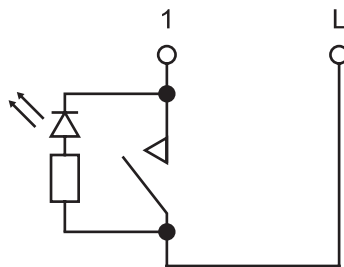

Switch 2 gang 1 way

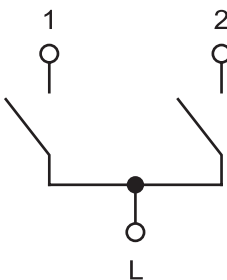

Switch 1 gang 2 pole 20 A

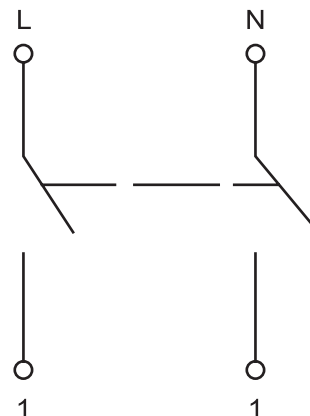



# CONNECTION SCHEME

Switch 1 gang 1 way

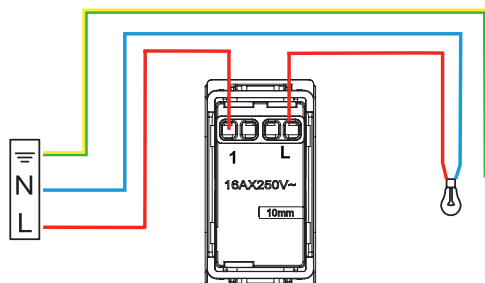

Switch 1 gang 2 pole 20 A

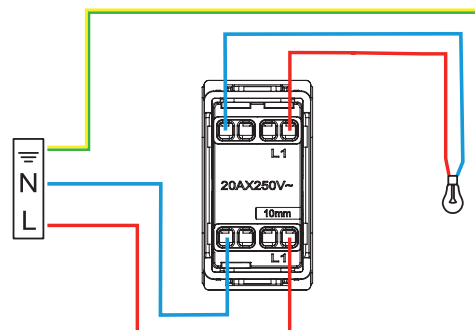

Switch 2 gang 1 way

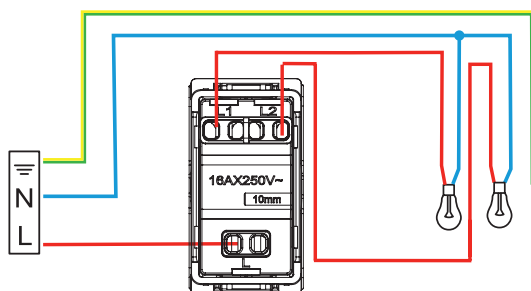

Dimmer

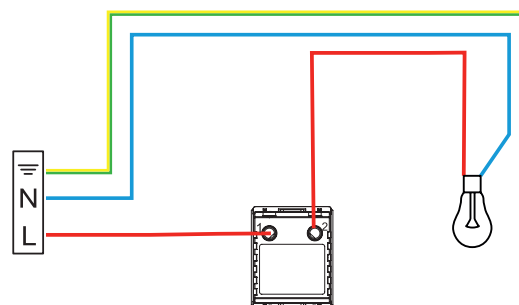

Lighting control from two locations

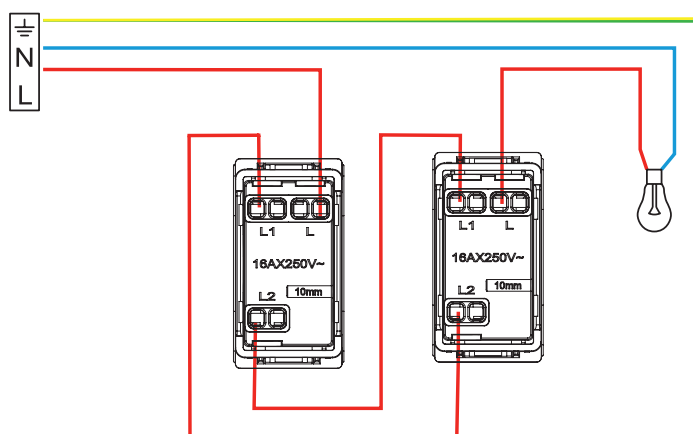

OFF

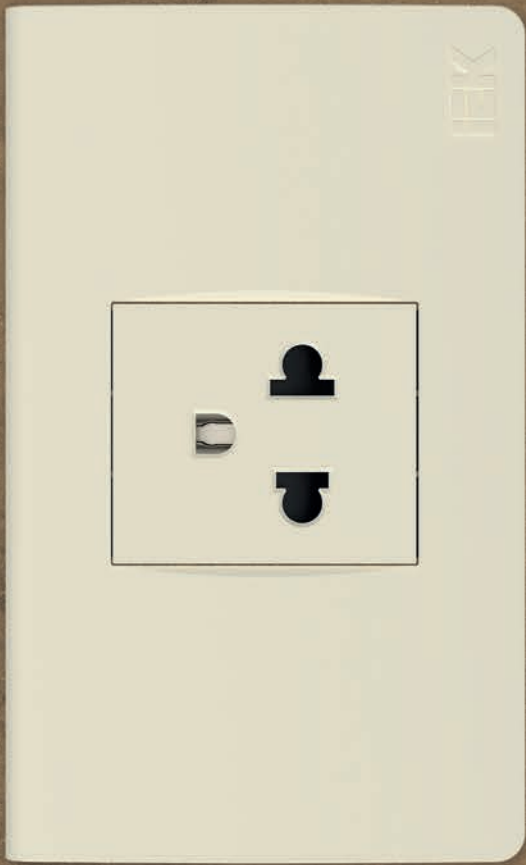

TURN ON



# SOCKETS

How to distribute electricity for different tasks and projects? With the help of LETO power sockets you can easily cope with this! Choose what you need: sockets with or without a grounding contact, double or single. The range of power sockets is presented in the form of mechanism modules installed in a metal support. LETO power sockets have the following standard sizes: 1/3, 1/2, 2/3, 3/3. Sockets are presented in two standards: American and universal, suitable for different types of plugs. The sockets are equipped with a reliable contact group, which increases their service life.

- **Universal arrangement of mechanisms**
- **Reliable connection**
- **Durable stainless steel screws for connecting conductors**
- **Non-flammable plastic**

## Specifications

**Flush mounted**  
Installation type

**230 V/50 Hz**  
Rated voltage

**16 A (for grounded sockets)**  
Rated current

**IP20**  
Protection degree

**Screws**  
Mounting method

**Screw terminals**  
Conductor connection

**Up to 4 mm<sup>2</sup>**  
Cross-section of connected conductors

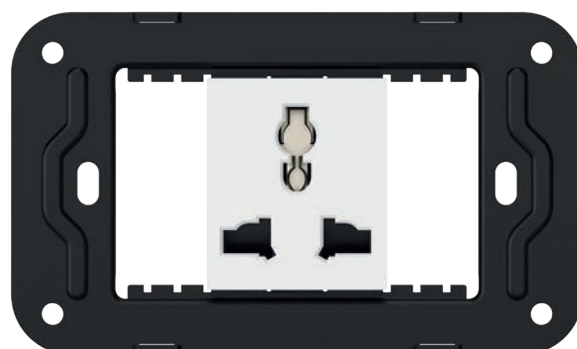

### Socket 1/3 American

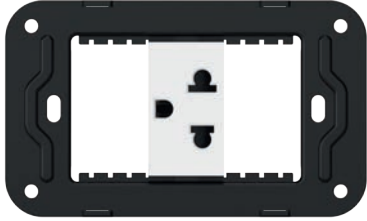

LE-R10-10-20-K01-F4-13-A	White glossy
LE-R10-10-20-K01-F3-13-A	White matte
LE-R10-10-20-K10-F3-13-A	Beige matte
LE-R10-10-20-K37-F3-13-A	Champagne matte
LE-R10-10-20-K45-F3-13-A	Bronze matte
LE-R10-10-20-K46-F3-13-AU	Steel matte
LE-R10-10-20-K02-F3-13-A	Black matte

### Socket 1/3 universal without ground

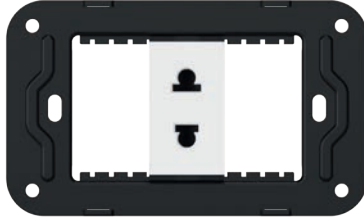

LE-R10-10-20-K01-F4-13-U	White glossy
LE-R10-10-20-K01-F3-13-U	White matte
LE-R10-10-20-K10-F3-13-U	Beige matte
LE-R10-10-20-K37-F3-13-U	Champagne matte
LE-R10-10-20-K45-F3-13-U	Bronze matte
LE-R10-10-20-K46-F3-13-U	Steel matte
LE-R10-10-20-K02-F3-13-U	Black matte

### Socket 1/2 American universal



LE-R10-10-20-K01-F4-12-AU	White glossy
LE-R10-10-20-K01-F3-12-AU	White matte
LE-R10-10-20-K10-F3-12-AU	Beige matte
LE-R10-10-20-K37-F3-12-AU	Champagne matte
LE-R10-10-20-K45-F3-12-AU	Bronze matte
LE-R10-10-20-K46-F3-12-AU	Steel matte
LE-R10-10-20-K02-F3-12-AU	Black matte

### Socket 1/2 universal

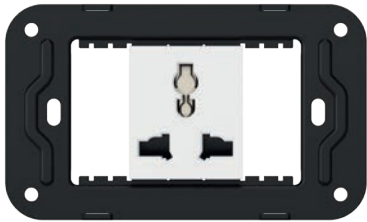

LE-R10-10-20-K01-F4-12-U	White glossy
LE-R10-10-20-K01-F3-12-U	White matte
LE-R10-10-20-K10-F3-12-U	Beige matte
LE-R10-10-20-K37-F3-12-U	Champagne matte
LE-R10-10-20-K45-F3-12-U	Bronze matte
LE-R10-10-20-K46-F3-12-U	Steel matte
LE-R10-10-20-K02-F3-12-U	Black matte

### Socket 2/3 American universal

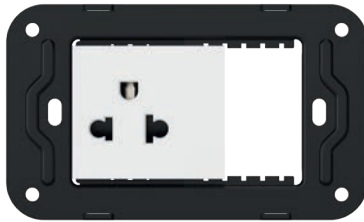

LE-R10-10-20-K01-F4-23-AU	White glossy
LE-R10-10-20-K01-F3-23-AU	White matte
LE-R10-10-20-K10-F3-23-AU	Beige matte
LE-R10-10-20-K37-F3-23-AU	Champagne matte
LE-R10-10-20-K45-F3-23-AU	Bronze matte
LE-R10-10-20-K46-F3-23-AU	Steel matte
LE-R10-10-20-K02-F3-23-AU	Black matte

### Socket 2/3 universal

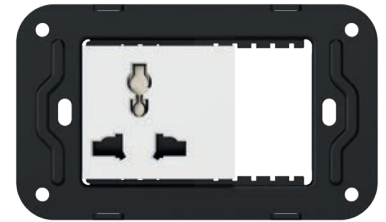

LE-R10-10-20-K01-F4-23-U	White glossy
LE-R10-10-20-K01-F3-23-U	White matte
LE-R10-10-20-K10-F3-23-U	Beige matte
LE-R10-10-20-K37-F3-23-U	Champagne matte
LE-R10-10-20-K45-F3-23-U	Bronze matte
LE-R10-10-20-K46-F3-23-U	Steel matte
LE-R10-10-20-K02-F3-23-U	Black matte

### Double socket 3/3 American universal



LE-R20-10-20-V-K01-F4-AU	White glossy
LE-R20-10-20-V-K01-F3-AU	White matte
LE-R20-10-20-V-K10-F3-AU	Beige matte
LE-R20-10-20-V-K37-F3-AU	Champagne matte
LE-R20-10-20-V-K45-F3-AU	Bronze matte
LE-R20-10-20-V-K46-F3-AU	Steel matte
LE-R20-10-20-V-K02-F3-AU	Black matte

### Double socket 3/3 universal

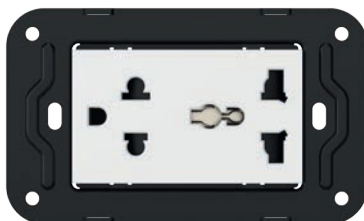

LE-R20-10-20-V-K01-F4-U	White glossy
LE-R20-10-20-V-K01-F3-U	White matte
LE-R20-10-20-V-K10-F3-U	Beige matte
LE-R20-10-20-V-K37-F3-U	Champagne matte
LE-R20-10-20-V-K45-F3-U	Bronze matte
LE-R20-10-20-V-K46-F3-U	Steel matte
LE-R20-10-20-V-K02-F3-U	Black matte

# SIZES

**3/3**

Double socket 3/3  
American universal

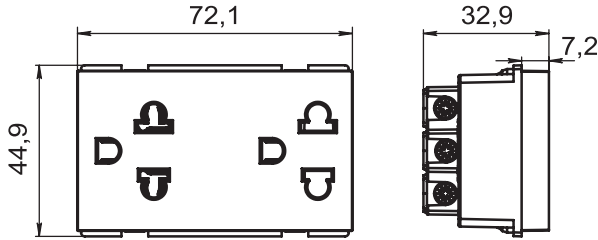

Double socket 3/3  
universal

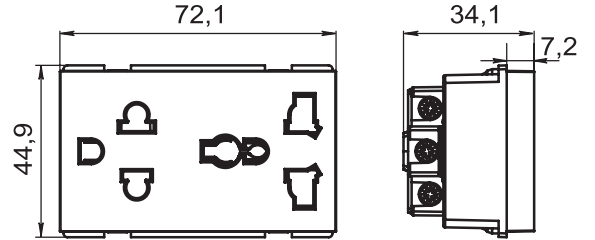

**2/3**

Socket 2/3  
American universal

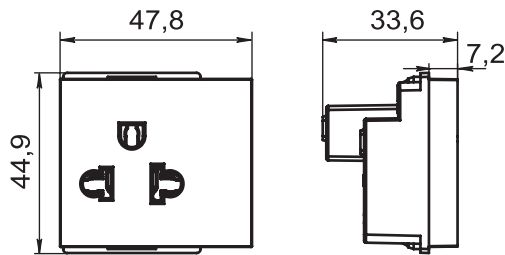

Socket 2/3  
universal

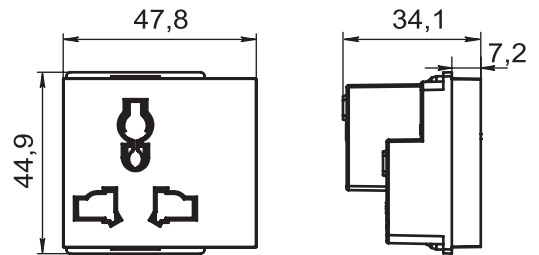

**1/2**

Socket 1/2  
American universal

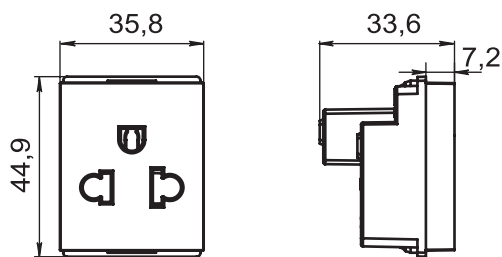

Socket 1/2  
universal

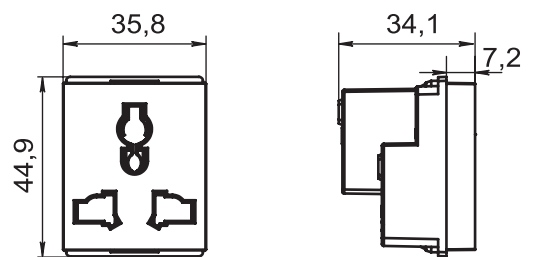

**1/3**

Socket 1/3  
American

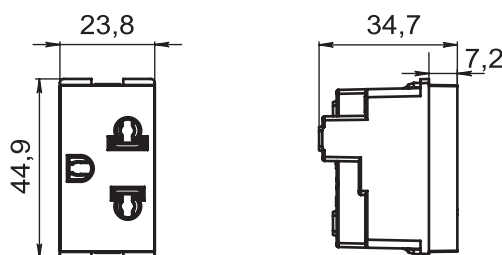

Socket 1/3 universal  
without ground

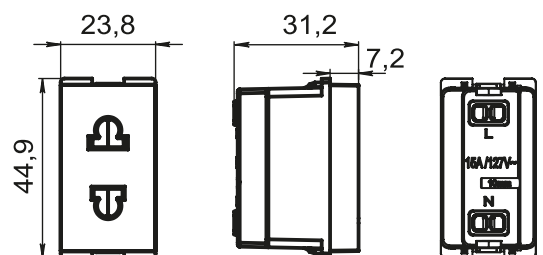

# ELECTRICAL SCHEME

American and universal sockets without ground

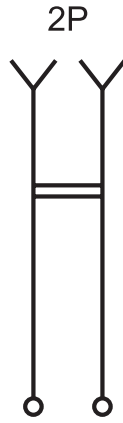

American and universal sockets with ground

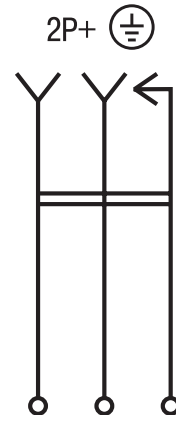

Double sockets without ground

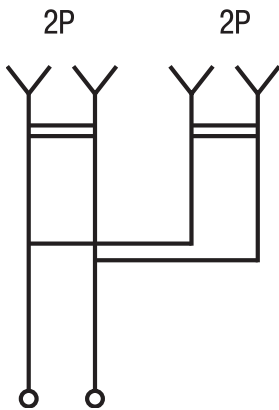

Double sockets with ground

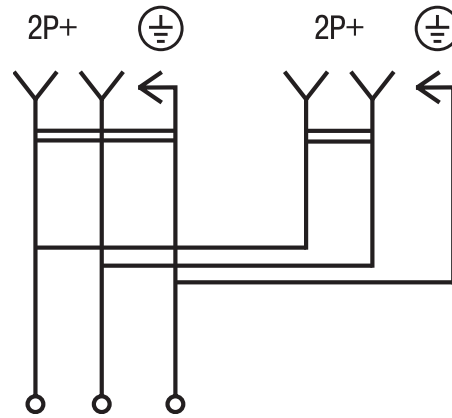

TURN ON **LETO**



Undoubtedly, one of the most crucial functional components of every apartment is its electrical sockets. Their presence in particular locations can either significantly improve our comfort and quality of life or, on the contrary, introduce chaos and inconvenience. Just imagine how unhandy it is when you have to use an extension cord, which can not only cause you to trip and fall but also cause our devices connected to this extension cord to be instantly smashed to smithereens. Hence the important rule: there are never too many sockets, and the fewer wires in the apartment, the better and safer. If you are making repairs and calculating how many sockets you need to install based on your existing electrical consumers, always make a reservation. We have been doing repairs for more than one year, and the world is developing so quickly that more and more useful devices are appearing, and we, finally, find ourselves in a situation where we no longer have enough sockets. However, there is another very important point to consider when choosing sockets. It is necessary to pay attention to the quality of the product and the materials used in the socket mechanism. After all, a socket is an element that carries a large electrical load. The network voltage is not always and everywhere as stable as we would like it to be. There are voltage surges due to various emergency situations, for example, short circuit current. In all such emergency situations, we are faced with the fact that the wire gets very hot. In this case, it is extremely important that the socket mechanism does not deform, much less melt or catch fire, but continues to maintain its mechanical and electrical properties. Leto series sockets offer a wide range of functionality and unsurpassed quality at all times.

00

TURN ON



TURN ON





# TELECOMMUNICATION SOCKETS

A high-quality TV picture and an excellent Internet signal are important requirements for modern real estate. Satellite sockets of the LETO series will ensure transmission of a television signal at a high level. Telephone and Internet sockets will help implement various projects and transmit information at excellent speed. The standard sizes used for these devices are 1/3, 1/2. RJ45 cat. 5e connectors are designed specifically to support high-speed computer networks operating at a bandwidth of 125 MHz. The transmission speed when using two pairs is up to 100 Mbit/s, four – up to 1000 Mbit/s.

- **High signal level**
- **Convenient connection**
- **The shutter in the RJ11, RJ45 connectors prevents dust from getting inside the connectors, which undoubtedly affects the signal level**

## Specifications

**Flush mounted**  
Installation type

**RJ11, RJ45, TV**  
Mechanism types

**IP20**  
Protection degree

**Screws**  
Mounting method

**Quick-locking**  
Contact clips for  
information sockets



### Socket 1/3 TV

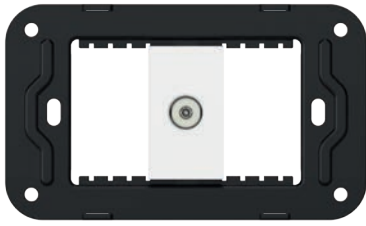

LE-A10-K01-F4-13	White glossy
LE-A10-K01-F3-13	White matte
LE-A10-K10-F3-13	Beige matte
LE-A10-K37-F3-13	Champagne matte
LE-A10-K45-F3-13	Bronze matte
LE-A10-K46-F3-13	Steel matte
LE-A10-K02-F3-13	Black matte

### Socket 1/3 RJ11 telephone



LE-T10-K01-F4-13	White glossy
LE-T10-K01-F3-13	White matte
LE-T10-K10-F3-13	Beige matte
LE-T10-K37-F3-13	Champagne matte
LE-T10-K45-F3-13	Bronze matte
LE-T10-K46-F3-13	Steel matte
LE-T10-K02-F3-13	Black matte

### Socket 1/3 RJ45 5E internet

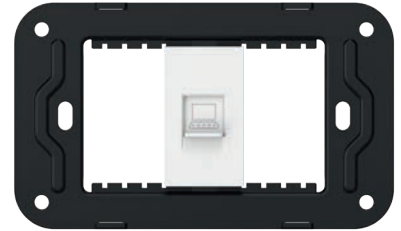

LE-K10-1-K01-F4-13	White glossy
LE-K10-1-K01-F3-13	White matte
LE-K10-1-K10-F3-13	Beige matte
LE-K10-1-K37-F3-13	Champagne matte
LE-K45-1-K45-F3-13	Bronze matte
LE-K10-1-K46-F3-13	Steel matte
LE-K10-1-K02-F3-13	Black matte

### Socket 1/2 TV



LE-A10-K01-F4-12	White glossy
LE-A10-K01-F3-12	White matte
LE-A10-K10-F3-12	Beige matte
LE-A10-K37-F3-12	Champagne matte
LE-A10-K45-F3-12	Bronze matte
LE-A10-K46-F3-12	Steel matte
LE-A10-K02-F3-12	Black matte

### Socket 1/2 RJ11 telephone



LE-T10-K01-F4-12	White glossy
LE-T10-K01-F3-12	White matte
LE-T10-K10-F3-12	Beige matte
LE-T10-K37-F3-12	Champagne matte
LE-T10-K45-F3-12	Bronze matte
LE-T10-K46-F3-12	Steel matte
LE-T10-K02-F3-12	Black matte

### Socket 1/2 RJ45 5E internet

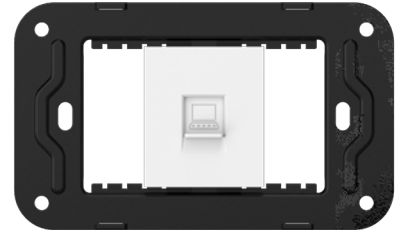

LE-K10-1-K01-F4-12	White glossy
LE-K10-1-K01-F3-12	White matte
LE-K10-1-K10-F3-12	Beige matte
LE-K10-1-K37-F3-12	Champagne matte
LE-K45-1-K45-F3-12	Bronze matte
LE-K10-1-K46-F3-12	Steel matte
LE-K10-1-K02-F3-12	Black matte

# ELECTRICAL SCHEME

TV



Telephone

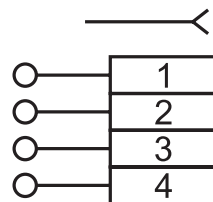

Internet

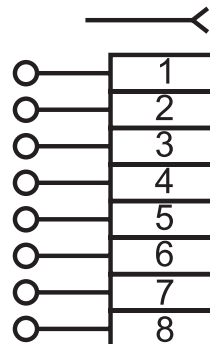

# SIZES

1/2

Socket 1/2 TV

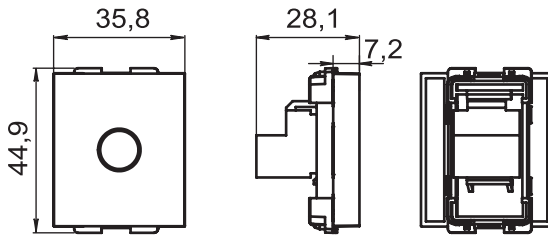

Socket 1/2 RJ11 telephone  
Socket 1/2 RJ45 5E Internet

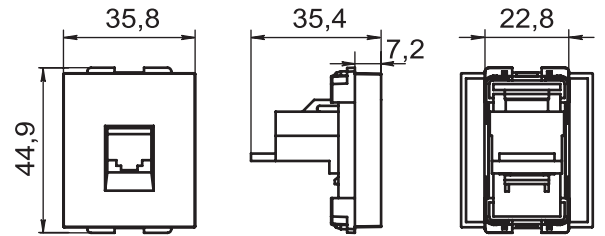

1/3

Socket 1/3 TV

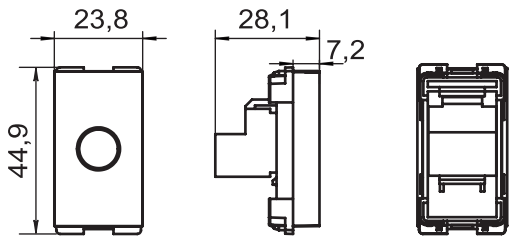

Socket 1/3 RJ11 telephone  
Socket 1/3 RJ45 5E internet

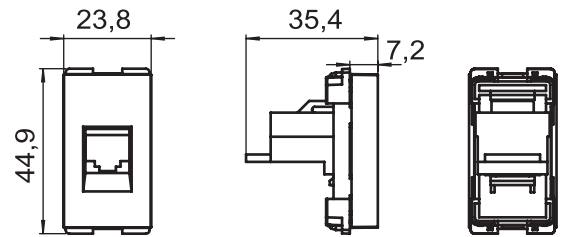

# CONNECTION SCHEME

TV

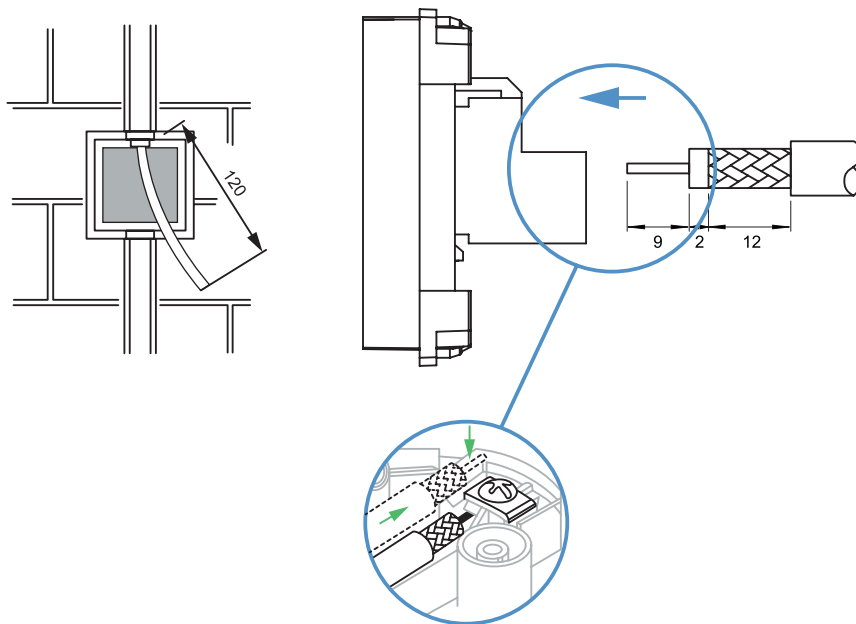

Telephone

Internet

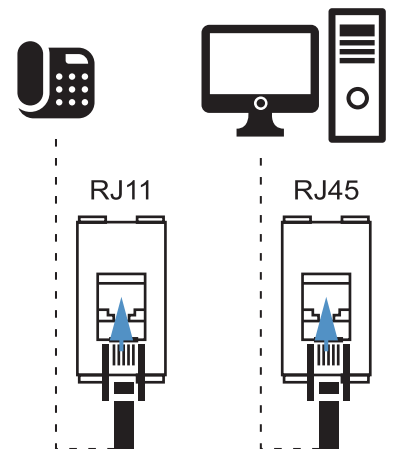

LEFO



TURN ON



# USB SOCKETS AND LIGHTING

LETO USB sockets are an excellent solution for charging gadgets and other multimedia devices. Combined USB sockets will allow you to charge two different devices at once from one power source. Mechanisms with fast charging will ensure your gadgets are charged in the shortest possible time.

- **Ease of use**
- **Fast charge**
- **Various USB output formats (type A, type C)**



## Specifications

### Flush mounted

Installation type

### 230 V/50 Hz

Rated voltage

### IP20

Protection degree

### Screws

Mounting method

### Screw terminals

Conductor connection

### Up to 2.5 mm<sup>2</sup>

Cross-section of connected conductors

### A+A (2.1 A), A+C (1.5 A; 3.1 A)

Charging current

### 5, 9, 12 V

Charging voltage

### Socket USB 1/3 A+A 5 V 2.1 A



LE-U21-D21-K01-F4-13	White glossy
LE-U21-D21-K01-F3-13	White matte
LE-U21-D21-K10-F3-13	Beige matte
LE-U21-D21-K37-F3-13	Champagne matte
LE-U21-D21-K45-F3-13	Bronze matte
LE-U21-D21-K46-F3-13	Steel matte
LE-U21-D21-K02-F3-13	Black matte

### Socket USB 1/2 A+C 18W fast charge



LE-U22-018-K01-F4-12	White glossy
LE-U22-018-K01-F3-12	White matte
LE-U22-018-K10-F3-12	Beige matte
LE-U22-018-K37-F3-12	Champagne matte
LE-U22-018-K45-F3-12	Bronze matte
LE-U22-018-K46-F3-12	Steel matte
LE-U22-018-K02-F3-12	Black matte

## SIZES

### Socket USB 1/3 A+A 5 V 2.1 A

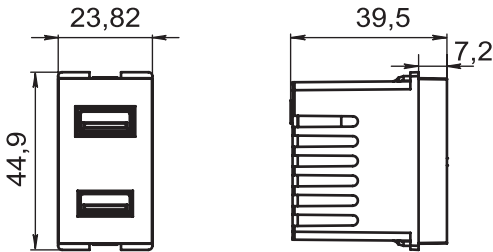

### Socket USB 1/2 A+C 18 W fast charge

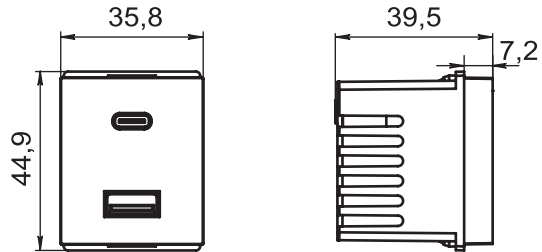

## ELECTRICAL SCHEME

### Socket USB

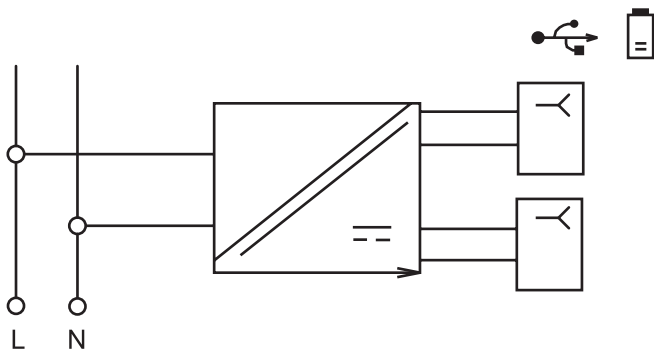

## Footlight 1/3

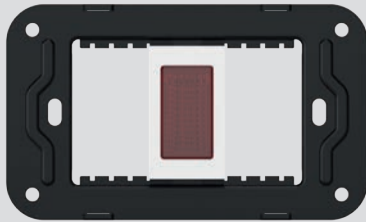

LE-FL30-K01-F4-13	White glossy
LE-FL30-K01-F3-13	White matte
LE-FL30-K10-F3-13	Beige matte
LE-FL30-K37-F3-13	Champagne matte
LE-FL30-K45-F3-13	Bronze matte
LE-FL30-K46-F3-13	Steel matte
LE-FL30-K02-F3-13	Black matte

## Specifications

**Flush mounted**  
Installation type

**230 V/50 Hz**  
Rated voltage

**25 mA**  
Rated current  
for switches

**0.6 W**  
Power consumption

**IP20**  
Protection degree

**Screws**  
Mounting method

**Screw terminals**  
Conductor connection

**From 0.5 to 1.5 mm<sup>2</sup>**  
Cross-section of connected  
conductors

**1500 K**  
Colorful temperature

**SMD**  
LED type

## SIZES

### Footlight 1/3

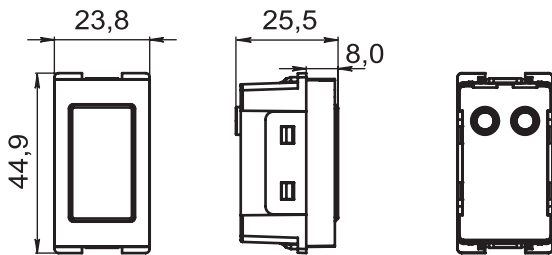

## ELECTRICAL SCHEME

### Footlight

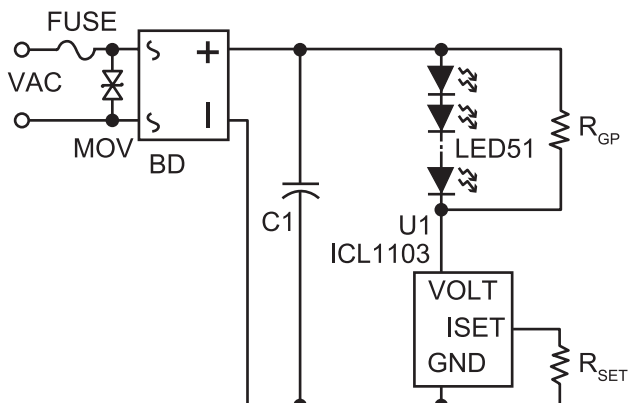

LEFLO



TURN ON





# FRAMES

The design concept of the LETO series frames is versatility, ergonomics and modernity. Our collection contains the most interesting colors to satisfy the most daring requests.

- **The frames are made of high quality plastic (polycarbonate)**
- **Seven colors**
- **Glossy and matte**
- **Frames are suitable for mechanisms of standard sizes 1/3, 1/2, 3/3, 2x1/3**



## Available colors

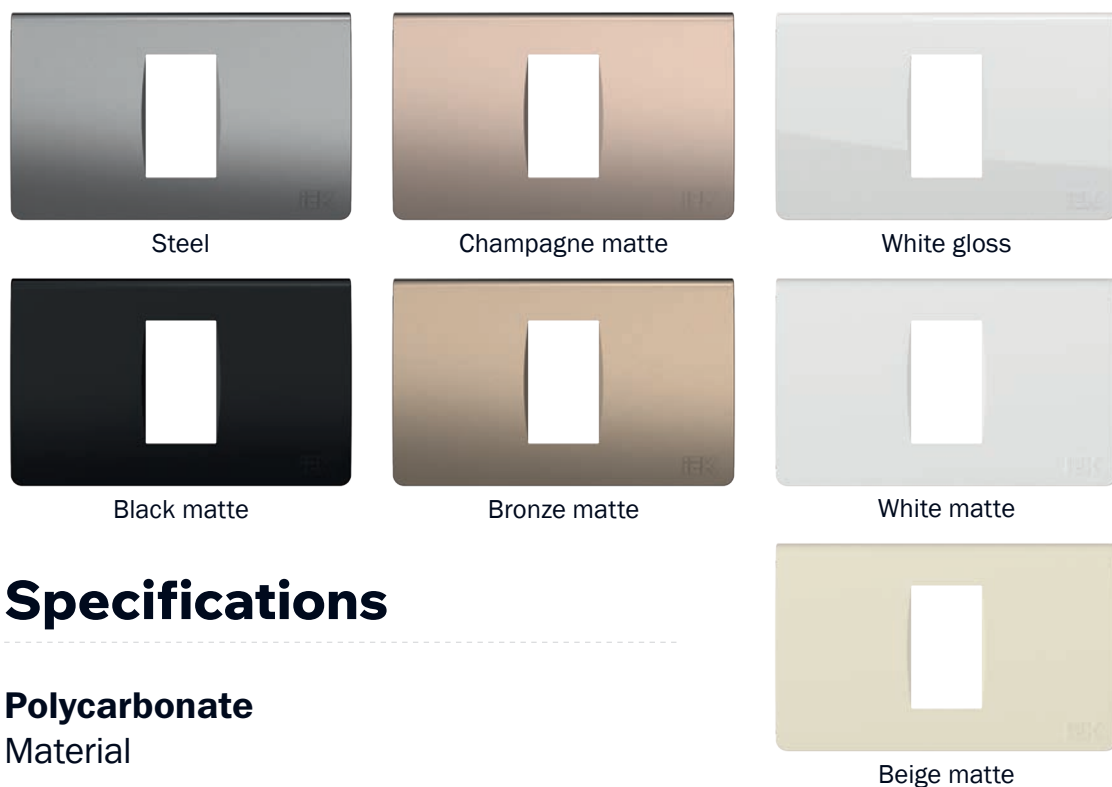

## Specifications

**Polycarbonate**  
Material

**UV resistance**

**Without tools, fastening to the caliper**  
Installation method

### Frame F6 1/3



LE-M20-P-04-1-20-K01-13	White glossy
LE-M20-P-03-1-20-K01-13	White matte
LE-M20-P-03-1-20-K10-13	Beige matte
LE-M20-P-03-1-20-K37-13	Champagne matte
LE-M20-P-03-1-20-K45-13	Bronze matte
LE-M20-P-03-1-20-K46-13	Steel matte
LE-M20-P-03-1-20-K02-13	Black matte

### Frame F6 1/2

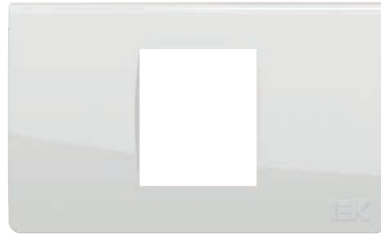

LE-M20-P-04-1-20-K01-12	White glossy
LE-M20-P-03-1-20-K01-12	White matte
LE-M20-P-03-1-20-K10-12	Beige matte
LE-M20-P-03-1-20-K37-12	Champagne matte
LE-M20-P-03-1-20-K45-12	Bronze matte
LE-M20-P-03-1-20-K46-12	Steel matte
LE-M20-P-03-1-20-K02-12	Black matte

### Frame F6 2/3



LE-M20-P-04-2-20-K01-23	White glossy
LE-M20-P-03-2-20-K01-23	White matte
LE-M20-P-03-2-20-K10-23	Beige matte
LE-M20-P-03-2-20-K37-23	Champagne matte
LE-M20-P-03-2-20-K45-23	Bronze matte
LE-M20-P-03-2-20-K46-23	Steel matte
LE-M20-P-03-2-20-K02-23	Black matte

### Frame F6 3/3



LE-M20-P-04-2-20-K01-33	White glossy
LE-M20-P-03-2-20-K01-33	White matte
LE-M20-P-03-2-20-K10-33	Beige matte
LE-M30-P-03-2-20-K37-33	Champagne matte
LE-M20-P-03-2-20-K45-33	Bronze matte
LE-M30-P-03-2-20-K46-33	Steel matte
LE-M20-P-03-2-20-K02-33	Black matte

There are four standard sizes of frames for mechanisms 1/3, 1/2, 3/3, 2/3, or for their different combinations. The frames are made of high quality plastic (polycarbonate), do not support combustion, and do not emit harmful substances at high temperatures (tested according to the RoHS standard). The design of the frames has centering lugs on the rear, allowing you to quickly install the frame on a metal support without the use of any tools.

TURN ON LETO

# SIZES

Frame F6 1/3

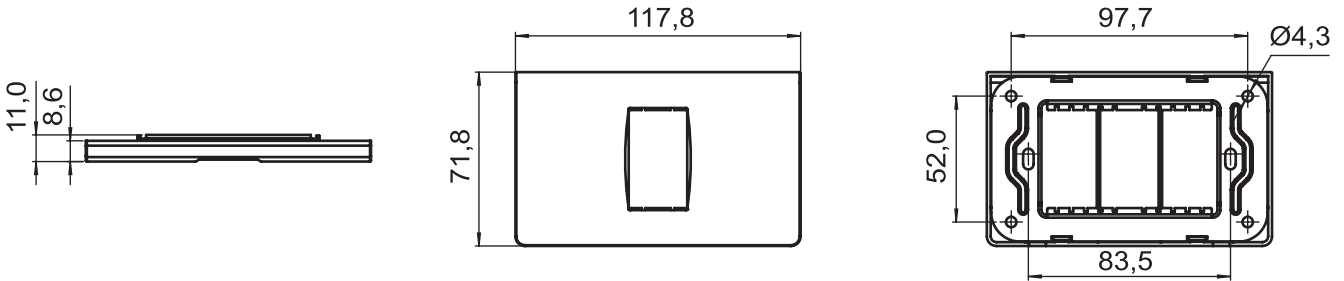

Frame F6 1/2

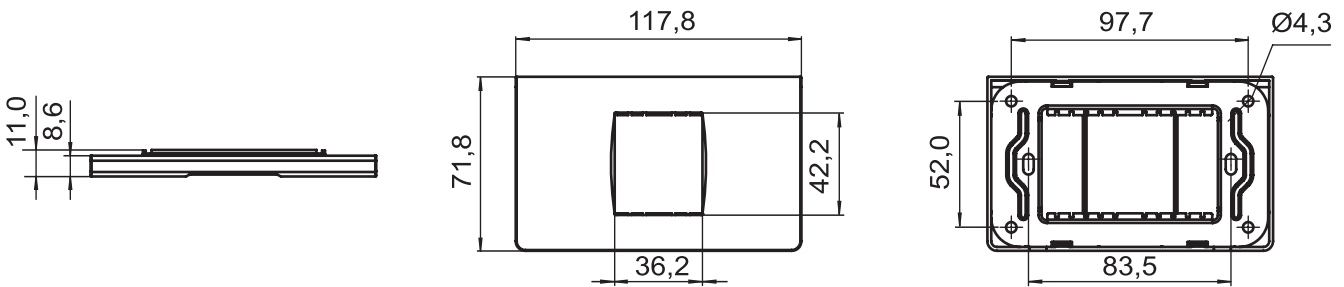

Frame F6 2/3

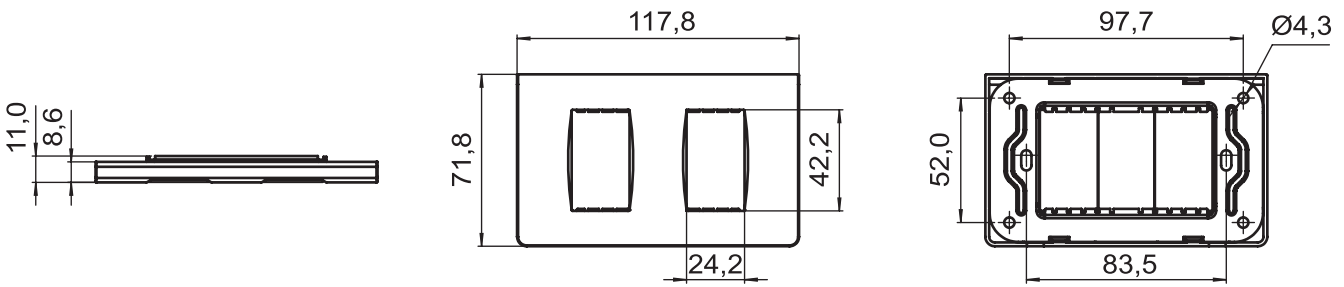

Frame F6 3/3

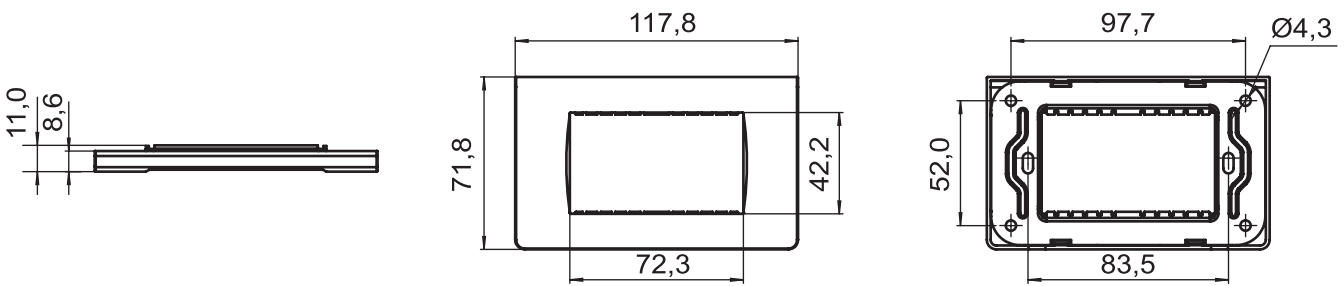

**iekglobal.vn**



**Where to buy IEK**

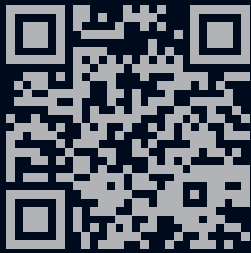

# TURN ON LETO

The IEK logo, consisting of the letters 'IEK' in a bold, black, sans-serif font. The 'I' and 'E' are connected at the top, and the 'K' is positioned to the right. The logo is set against a bright yellow square background.

Since 1999, IEK GROUP has been creating products that can win the hearts of our customers. We are well aware of how important it is for each of us to have safety, comfort, and convenience in everything that surrounds us.

Therefore, we have created a new LETO series wiring accessories safe in all respects during installation and operation. We are 100% confident in the quality of our products because we use the materials of the highest standards and check our products at all stages of production.

LETO wiring accessories with a wide range of sockets and switches can satisfy the wildest wishes of our customers and give your space a complete and harmonious look.

With love and care for you and your home IEK GROUP presents new wiring accessories of the LETO series.

